

Data Sheet



Article number: 5861421410

Description: Push-on fitting 14.214-10, metal $\text{Ø}10/8\text{-G } 1/4\text{'-}\text{Ø}10/8$
Banjo Tee

Measures

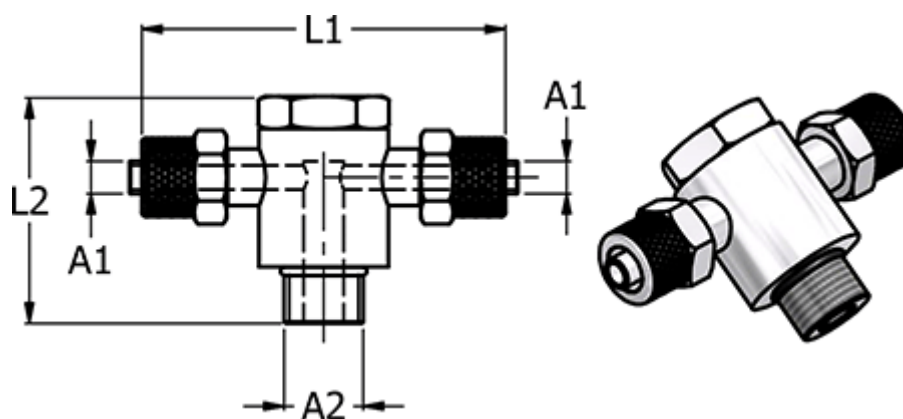

Hose diameter A1	= 10/8
L1	= 55.0
L2	= 33.0
NV	= 17
Thread A2	= G 1/4"